



WALL HUNG ELECTRIC BOILER
ATTACK®
ELECTRIC EXCELLENT



INSTRUCTIONS FOR USE



WWW.ATTACK.SK

Contents

1. General information

1.1 Description and use	4
1.2 Advantages of boiler	4
1.3 Important directions and advises	4
1.3.1 Mounting	5
1.3.2 Putting into operation	5
1.3.3 Boiler operation	5
1.3.4 Safety	5
1.4 Main dimensions	6
1.5 Technical data	7
1.6 Main parts	8
1.7 Description of functions	9
1.7.1 Technical description	9
1.7.2 Principle of boiler operation	9
1.7.3 Control unit and control panel	9
1.7.4 Protection function of the boiler	10
1.7.5 Safety function of the boiler	10
1.8 Circuit diagram	11

2. Boiler attendance

2.1 Control panel	16
2.2 Switch on/off	18
2.3 Operation modes	18
2.3.1 Operation mode (heating water)	18
2.3.2 Operation service utility water (sanitary water)	20
2.4 Setting of boiler parameters	21
2.5 Breakdowns	27

3. Installation

3.1 Norms and regulation	28
3.2 Placement of the boiler	28
3.3 Mounting of the boiler on the wall	28
3.4 Electroinstallation	28
3.4.1 Connection of the boiler to electric supply netw.	28
3.4.2 Installation of the room thermostat	29
3.4.3 Installation of mode TUV	29
3.5 Heating system	29
3.6 Expansion vessel	29
3.7 Marking of working scale	30
3.8 Circle pump	30

4. Termination of operation 31

5. Maintenance 31

6. Full delivery 31

7. Transport and warehousing 31

8. Claims 32

9. Way of liquidation 32

10. Enclosures 32

10.1 Installation of room thermostat 33

10.2 Face of control unit 33

Meaning of abbreviations and used symbols

- OV** - heating water
- TUV** - service utility water (sanitary water)
- ZOV** - storage water tank
- TMV** - three ways valve



Notice pay attention

Dear customer,

You have bought a modern product – the direct heated electric boiler ELECTRIC EXCELLENT from the company ATTACK, s.r.o., Slovak Republic. We believe that our

product will serve you good and for long time. It is necessary for you to study whole instruction manual and hold all the principles. The declaration of conformity was issued by the producer according to directives 2004/108/EC, 2006/95/EC,

Basic features

- ▶ Boilers ATTACK® are electric, using water for heating. It is electric wall-hung appliance determined for heating of family houses or flats with heat loss to 22,5 kW.
- ▶ The boiler could be used for heating of service utility water (sanitary water) through storage water tank.
- ▶ The boiler could be remote controlled by GSM.

Advantages of your boiler

SIMPLE CONTROL – your new boiler is in operation automatically. After boiler professional putting into operation is not necessary any additional setting. The boiler will adapt to conditions of your heating system

DIMENSIONS – your new boiler is really small regarding its dimensions. You can place it anywhere where is impossible to place another type of boilers.

REMINDER!

Your new boiler is not stay alone to be useful for your comfort, use good outside insulation of your flat or your house, use the room thermostat for economical consumption of electric energy.

ATTACK, s.r.o

1. General information

1.1 Description and use

The wall hung electric boiler ELECTRA EXCELLENT is convenient for heating in heating systems with forced circle and for heating of service utility water (sanitary water).

The heating of heating water takes place in a boiler drum by means of one (EXCELLENT 08), two (EXCELLENT 15) or three (EXCELLENT 24) heaters of a power output of 4,5 kW, 6 kW or 7,5 kW. Each heater consists of three heating rods of a power output of 1,5 kW, 2 kW or 2,5 kW each. Heating operation is controlled by control unit with PID regulation. PID regulation assures high efficient operation due to minimizing of heating water temperature overshoots over temperature setting. This regulation saves also your energy consumption. The boiler could be regulated by the room thermostat and it also able to heat sanitary water in an independent storage water tank connected through with 3-ways motoric valve.

1.2 Advantages of boiler

- ▶ small dimensions, modern design
- ▶ high efficiency 99 %
- ▶ silent operation
- ▶ information on the display
- ▶ mode relay independent to the control unit cost saving regarding replacement
- ▶ step less regulation of boiler output with continuous switching on/off heating elements economic operation
- ▶ rotation of heating elements ensuring elongation of lifetime
- ▶ possibility of using the boiler for under floor heating system
- ▶ breakdowns diagnostic system with display indication
- ▶ information about heating system pressure thermo manometer
- ▶ operation mode Stand-by ensuring termination of boiler operation with all protective functions:
 - ▶ protective functions:
 - ▶ antifreeze
 - ▶ deblocking
 - ▶ against overheating
 - ▶ against pressure lost
 - ▶ pump running out regulated by time or temperature
- ▶ possibility of remote control with GSM
- ▶ possibility of equitermic operation
- ▶ possibility of connection with a storage water tank
- ▶ possibility of a room thermostat connection
- ▶ automatic deaerating
- ▶ breakdowns statement memory
- ▶ function back to factory setting.

1.3 Important instructions and advices

Regarding installation, putting the boiler into operation and maintenance it is necessary to observe instructions according to concrete norms and regulations and instructions from the producer. It is also necessary for you to read carefully instruction manual and guarantee conditions.

- ▶ Control if the boiler in the box is completed regarding accessories etc.
- ▶ Control if the boiler type is in accordance with your request for use.
- ▶ The data stated on the type label has to be compatible with conditions for boiler connection and mounting.
- ▶ It is not allowed for user to manipulate with parts plumbed.

1.3.1 Installing, mounting of the boiler

- ▶ Safety and economic operation of the boiler requests a technical project made by authorized heating or civil engineer for whole heating system.

- Mounting of the boiler could be carried out only by authorized company or persons.
- On the boiler and 100mm before the boiler there is not allowed a placement of things from flammable materials.
- The boiler mounted on the wall is not able to be moved or placed to another place.
- Boiler connection is allowed only with nut with flat ring sealing.
- It is necessary to put heating water inlet with a filter and shut off valves.
- It is necessary to leave a free space on both side walls of the boiler 100 mm and minimally 400mm from the top for after sales service. In case that you will not observe this request for free space you have to pay dismantling and mounting the boiler back to the wall and to heating system, it is not a repair paid in guarantee period!

1.3.2 Putting into operation

- Putting the boiler into operation has to be carried out only by authorized professional company or service person that has a valid agreement signed with the producer. The list of these companies is enclosed.
- The company or person who will put the boiler into operation has an obligation to assure repairs of breakdowns or defects in guarantee period. In case that this company doesn't exist anymore, the guarantee repair will be assured by any company from the list closed to you.
- By putting the boiler into operation the authorized person is obligated to:
 - control connections of the boiler to electric supply network and to heating system
 - control tightness of the boiler
 - control all functions of the boiler
 - inform the user about boiler operation, its control and maintenance
- inform the user about safety dimensions from sides of the boiler from flammable walls and its protection according to ČSN 0611008 and ČSN 730823.
- To fulfil requests for boiler safety and economic operation it is necessary to observe below mentioned conditions:
 - for boiler mounting and installing the user has to get the permission from the company who is a distributor of electricity in your region, control the input of the boiler if it is in accordance with the input stated in the permission
 - for mounting of the boiler it is necessary to have an authorized technical project for heating system and for connection of electric boiler
 - the boiler is able to be mounted only in an environment according to its determination and according to the project
 - manipulation, operation, using, control and maintenance of the boilers are forbidden if it is not in accordance with rules and directions of this instruction manual. It is forbidden mainly to disconnect any of

safety units or elements in the boiler!!!

- If the guarantee list is not filling fully, it is not valid

If you take the boiler from the colder environment to the warmer one (for example if the outside temperature is below 0° C or 0° C and you want to mount it inside), please wait approximately 2 hours.



1.3.3 Operation of the boiler

- The boiler has to be controlled and used only according to advices and instructions stated in this instruction manual, only by adult person who was posted in maintenance of the boiler. Putting the boiler into operation will made by authorized service person during the heating test.
- Any manipulation, operation, using and maintenance of the boiler, which is not in accordance with instructions and advices stated in this instruction manual, is inadmissible. The producer is not responsible for damages caused by wrong using and maintenance of the boiler.
- The producer recommends periodical service controls of the boiler 1x per year before heating season. The service control could be done only by a professional authorized service company or person. The list of service control steps recommend to be controlled before heating season you will find in the chapter "maintenance".
- The producer allows only room thermostat connection, if the room thermostat has with potential-free outlet connection. The authorized service person is responsible during putting the boiler into operation to fill and sign guarantee card.
- If you find any breakdown or any defect on an electrical part of the boiler, please, don't repair it by yourself, disconnect the boiler from the electric supply network and ask for after sales service person.
- It is not allowed to use the boiler ELECTRIC-EXCELLENT for another purposes than is stated in this instruction manual.

1.3.4 Safety

Fire instructions:

- Disconnect the boiler from the electric supply network and take out it out of its operation according to possibilities.

Extinguish fire using pulverized or snows extinguish appliance flammable and explosive materials

- Don't stock any flammable and explosive things closed to the boiler (for example paper, colours, chemicals etc.)



1.7 Description of function

1.7.1 Technical description

The boiler is designed according to valid norms

1.4 Main dimensions

Dimensions in mm.

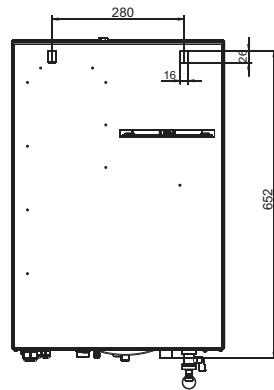
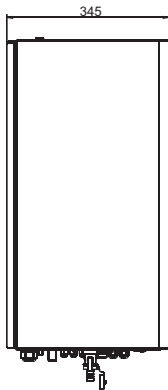
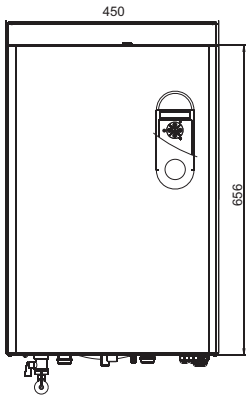
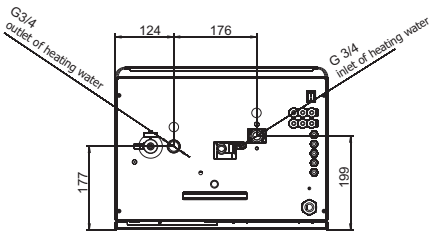

1.5 Technical data

Boiler type Electric parameters	Unit	ELECTRIC 08	ELECTRIC 15	ELECTRIC 24
		EXCELLENT	EXCELLENT	EXCELLENT
Total electric input	kW	7,5	15	22,5
Nominal heating output	kW	7,5	15	22,5
Heater power output		3x2,5	2x3x2,5	3x3x2,5
Nominal current	A	3x12 / 1x36	3x24	3x36
Electric network*	V	3x230/400V+N+PE/50 Hz*		
Electric network	V	1x230V+N+PE/50 Hz		
Nominal current max.	A	3x12 / 1x36	3x24	3x36
Pump input	W	50/60/70		
Main circuit breaker	A	3x16 / 1x40	3x25	3x40
Nominal current of control fuse	A	0,315		
Enclosure	IP	40		
Mechanical parameters				
Mechanical life time of relay	-	1 000 000 cycles		
Electrical life time of relay		250 000 cycles, 16 A, 250 V		
Width	mm	450	450	450
Height	mm	656	656	656
Depth	mm	345	345	345
Boiler weight without water	kg	36,5	38	39,5
Environmental requests				
Min. working overpressure of heating system	bar	0,4		
Max. working overpressure of heating system	bar	3		
Operation overpressure recommended	kPa/bar	100/1		
Circle pump	-	UPM3 FLEX AS 15-70		
Maximal temperature of heating water	°C	80		
Expanding temperature of thermostat blocked, opened-closed system	°C	100		
Water volume of whole boiler	l	10,6		
Environmental kind ČSN 332000-3	-	normal AA5, AB5		
Efficiency by nominal output	%	99		
Supply cable CYKY**	mm ²	5x2,5 / 1x6	5x4	5x6
Supply cable AYKY**	mm ²	5x4 / 1x10	5x6	5x10
Expansion vessel	l	8		
Surrounding temperature	°C	0 + 40		
Warehousing and transport temperature	°C	-30 + + 70		
Electromagnetic temperature	-	EN 55014-1(2006)		
Humidity	%	0 + 90 without condensation		
Regulation				
Measuring accuracy	%	< 1	< 1	< 1
Accuracy of boiling water regulation	°C	± 1	± 1	± 1
Regulation type	-	PI		
Remote control				
Cascade	-	with cascade controller		
Service plug	-	6 PIN		
Number of boilers in cascade max.	-	according to the cascade controller		

* Y - connection

**Supply lead has to be proposed in preference in conformity with the norms.

***2 x 3 x 1,5

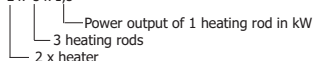

1.6 Main parts

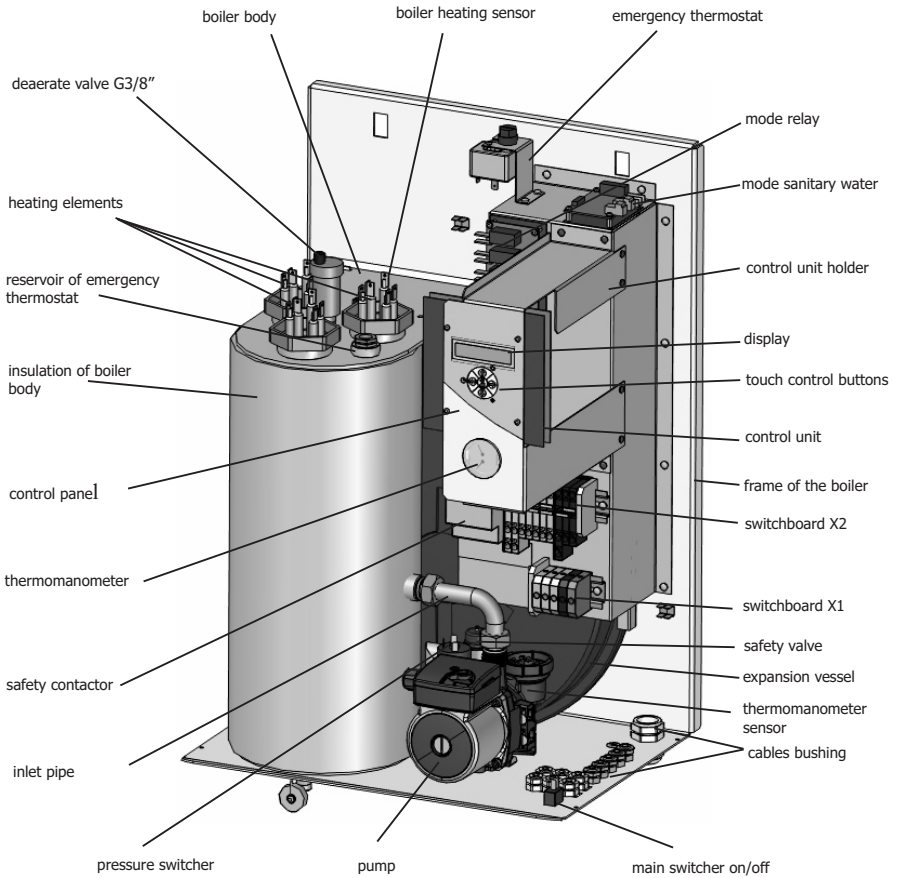

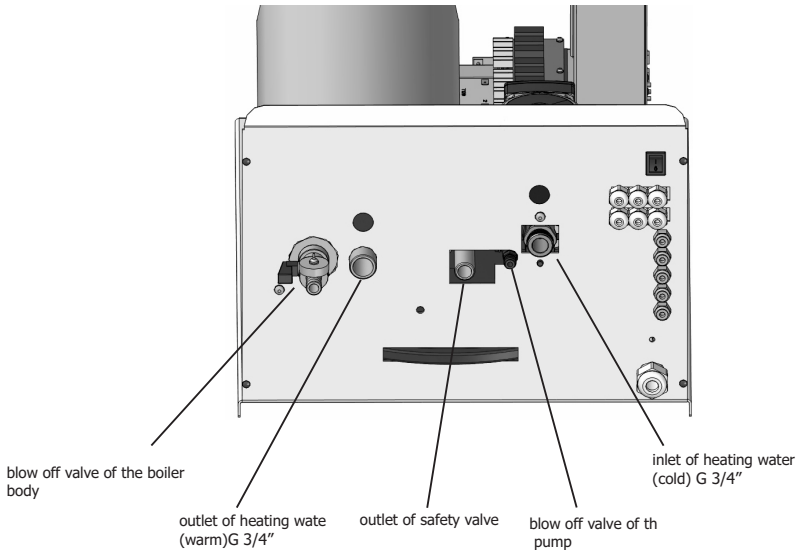

and rules ČSN EN and IEC. The safety of the boiler, energy saving and sound was important matter during the boiler designing.

1.7.2 Principle of boiler operation

The insulated boiler body with volume 10,6 l is a reservoir where water is heated by electric heating elements according to the boiler type, by one (08 kW), two (15 kW) or three (24 kW). Depending on the actual heat requirement, individual heating rods are connected, each of them having a power output of 1,5 kW for Comfort 05 and Comfort 09 (1 heating rod = 1,5 kW, 6 heating rods 9 kW), a power output of 2 kW for Comfort 06, Comfort 12 and Comfort 18 (1 heating rod 2 kW, 9 heating rods 18 kW) or a power output of 2,5 kW for EXCELLENT 15 and Comfort 24 (1 heating rod = 2,5 kW, 9 heating rods 22,5 kW). Circulation of water is through the pump. Safety of boiler operation is monitoring by several independent sensors. Whole heating process and pump operation is controlled by the control unit with display and push touch control buttons. The button 0/1 is for switching off the boiler out of operation.

1.7.3 Control unit and control board

Control unit has several functions which assure basic characteristics, mainly:

- safety functions assure protection against the of health and property

- user's functions functions set by the user
- operation functions internal functions of control unit import for sound operation of the boiler, but un-get-at-able for the user

Control unit could be in below mentioned modifications:

- basic only for heating = control unit + mode relay
- for heating and heating of sanitary water = control unit + mode relay + mode TUV (sanitary water)
- for heating with GSM remote control = control unit + mode relay + mode GSM
- for heating and heating of sanitary water with GSM remote control = control unit + mode relay + mode TUV (sanitary water) + mode GSM.

Control unit works with below mentioned inlet signals:

- temperature of heating water (sensor NTC)
- outside temperature (sensor NTC)
- room temperature (sensor NTC)
- temperature of sanitary water (sensor NTC) only if the boiler has connected TUV (sanitary water) sensor
- switching on signal of sanitary water heating 230 V (only if the boiler has TUV (sanitary water) mode)
- room thermostat signal potential free switcher
- signal of relay lightning in the first level potential free switcher

- signal of relay lightening in the second level potential free switcher
- HDO (mass remote control) signal potential free switcher
- signal HDO (mass remote control) activation of "working zero" N
- breakdown signal of floor overheating potential free switcher
- breakdown signal of overheating 230 V
- breakdown signal of pressure loss 230 V
- signal of GSM mode

Control unit controls:

- mode relay heating elements
- mode relay pump
- mode TUV (sanitary water) three ways valve for TUV

1.7.4 Antifreeze protection of the boiler

Antifreeze protection of the boiler

- This function protects the boiler against freeze and is active in the mode STAND-BY.
- Circulation pump and the boiler are in operation, if temperature of heating water decreases below 5 °C. In this case the boiler assures minimal level of heating and the system is mildly warm, the boiler heats to 15 °C temperature of heating water and after that the boiler set back to mode that it start to operate from. Pump running of is active.
- In case that the boiler is in the summer mode (permanent heating of storage water tank) and the temperature of heating water decreases below 5 °C then the antifreeze protection function is activated for heating system, after the boiler catch the temperature 15 °C, then the 3-ways valve go back to the position for heating of sanitary water and pump running of is also active.

If the boiler is switched off or out of electric supply, this function is not active.

Unlocking protection of heating system



- It is active at all times if the circulation pump or 3-ways valve is more than 24 hours out of operation to protect blocking of the pump or the valve due to its small parts. This function avoids blocking of the pump rotor in mode

STAND-BY and elongates its lifetime.

- The pump works 1 time per day for 10 s.

1.7.5 Safety function of the boiler

Control unit

- The control unit is designed according to valid EU norms and is certified.

- The control unit has a protection against below and over voltage
- The control unit is protected by system Watch-Dog-Timer with time 512 ms against its processor "blocking". In case that the processor is blocking the automatic reset function is activated and then the program is going with all parameters set from the point where it was broken

Protection against overheating

- The boiler has an emergency thermostat set for 100 °C. In case of boiler overheating heating elements are put out of operation independently to the control unit. This breakdown is signaling on the display as a critical breakdown No. 5. This breakdown could be repaired only by authorized service man.

Protection against lost of heating water pressure

- The boiler equipped with a pressure switcher which control minimal pressure in heating system 0,4 bar, when the function reliability of deaerate valves is assured, it means that the boiler has sufficient volume of water.
- In case of lost of heating water pressure below 0,4 bar the boiler signs the critical breakdown No. 4 and heating elements are put out of operation independently to the control unit.
- This breakdown could be repaired after the control of tightness of water ways and after water filling over 0,4 bar. After that the boiler is automatically reset and returned to normal operation.

Boiler protection against over and below voltage in supply electrical net

- The control unit is equipped with function assuring putting the boiler out of operation if the voltage is below 150 V or over 250 V. This stage is marked on the display like a critical breakdown No. 8. Below voltage is not marked on the display.
- When the voltage is OK = in the scale 150 250 V, the boiler returns to normal operation.

Boiler protection against overpressure of heating water

The boiler pump is equipped with pressure safety valve set for 3 bars. In case of the overpressure more than 3 bars the leakage of water occurs from the valve till the pressure of water in heating system is not below maximal requested level.

This valve is in its operation automatically.

Circuit diagram for connection of the boiler EK09K, EK12K, EK 15K to supply electrical net 3x230V/400V

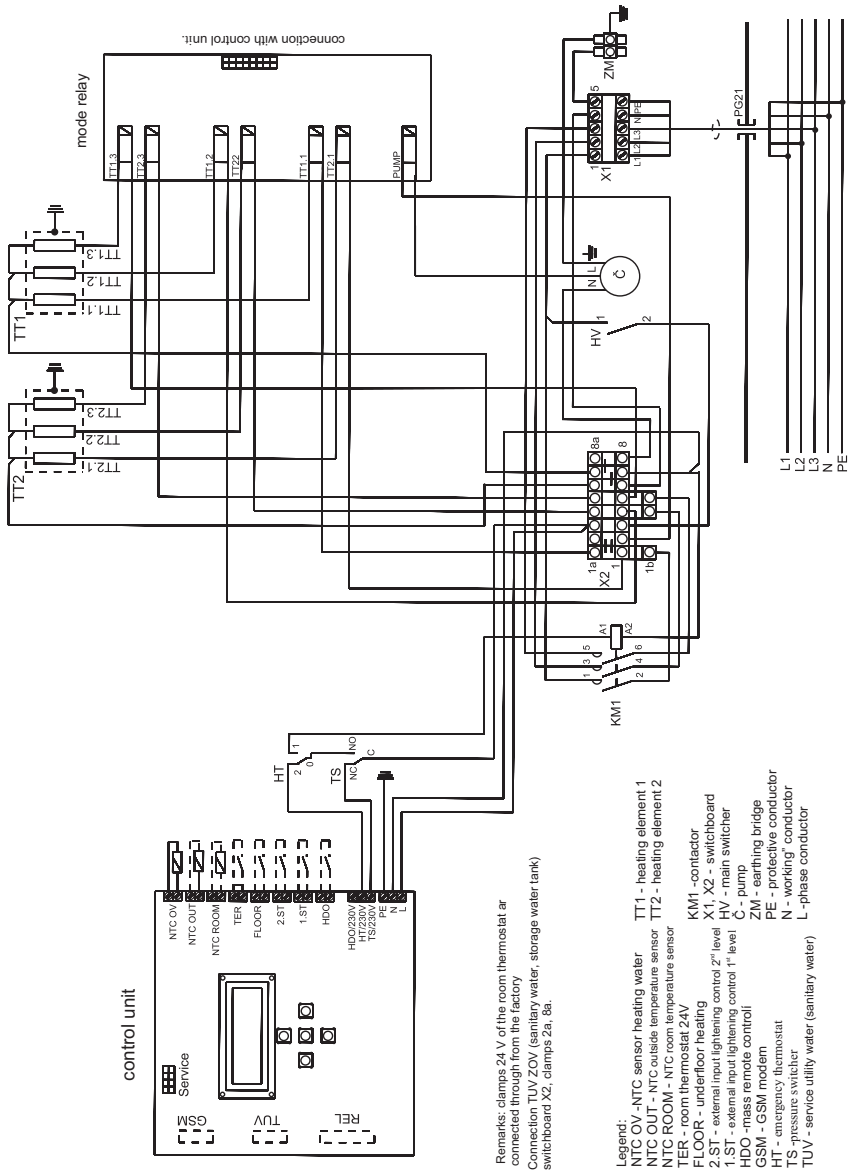

Circuit diagram for connection of the boiler EK 05K, Ek 06K, EK 08K to supply electrical net 3x230V/400V

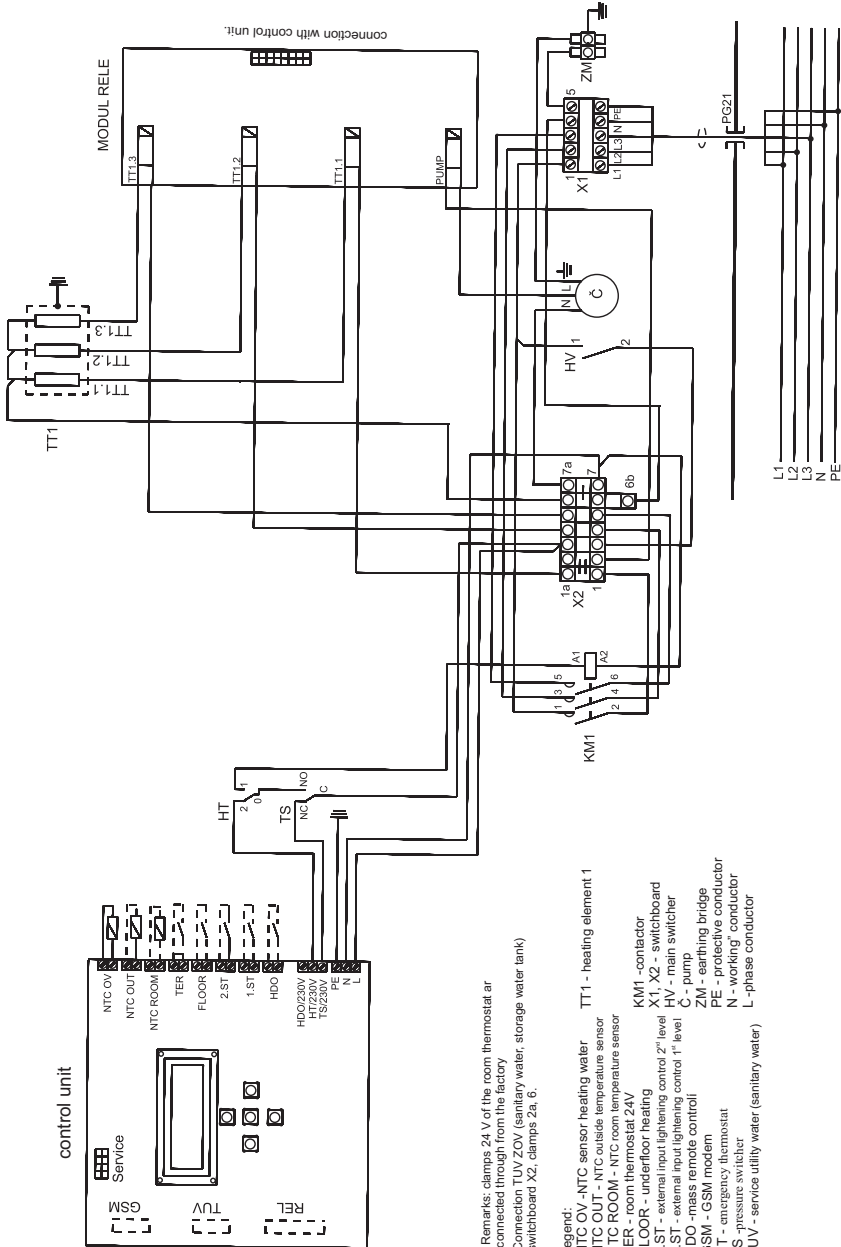

Remarks: damps 24 V of the room thermostat ar
connected through from the factory
Connection 1-V ZOV (sanitary water, storage water tank)
switchboard X2, damps 24, 6.

Legend:

- NTC OV - NTC sensor; heating water
- NTC OUT - NTC outside temperature sensor
- NTC ROOM - NTC room temperature sensor
- TER - room thermostat 24V
- FLOOR - underfloor heating
- 2ST - external (input) lighting control 2nd level
- 1ST - external (input) lighting control 1st level
- HDO - mass remote control
- GSM - GSM modem
- HT - emergency thermostat
- TS - pressure switcher
- TUV - service utility water (sanitary water)
- TT1 - heating element 1
- X1, X2 - switchboard
- HV - main switch
- C - pump
- ZM - earthing bridge
- PE - protective conductor
- N - working conductor
- L - phase conductor

Circuit diagram for connection of the boiler EK 05K, EK 06K, EK 08K to supply electrical net 1x230V

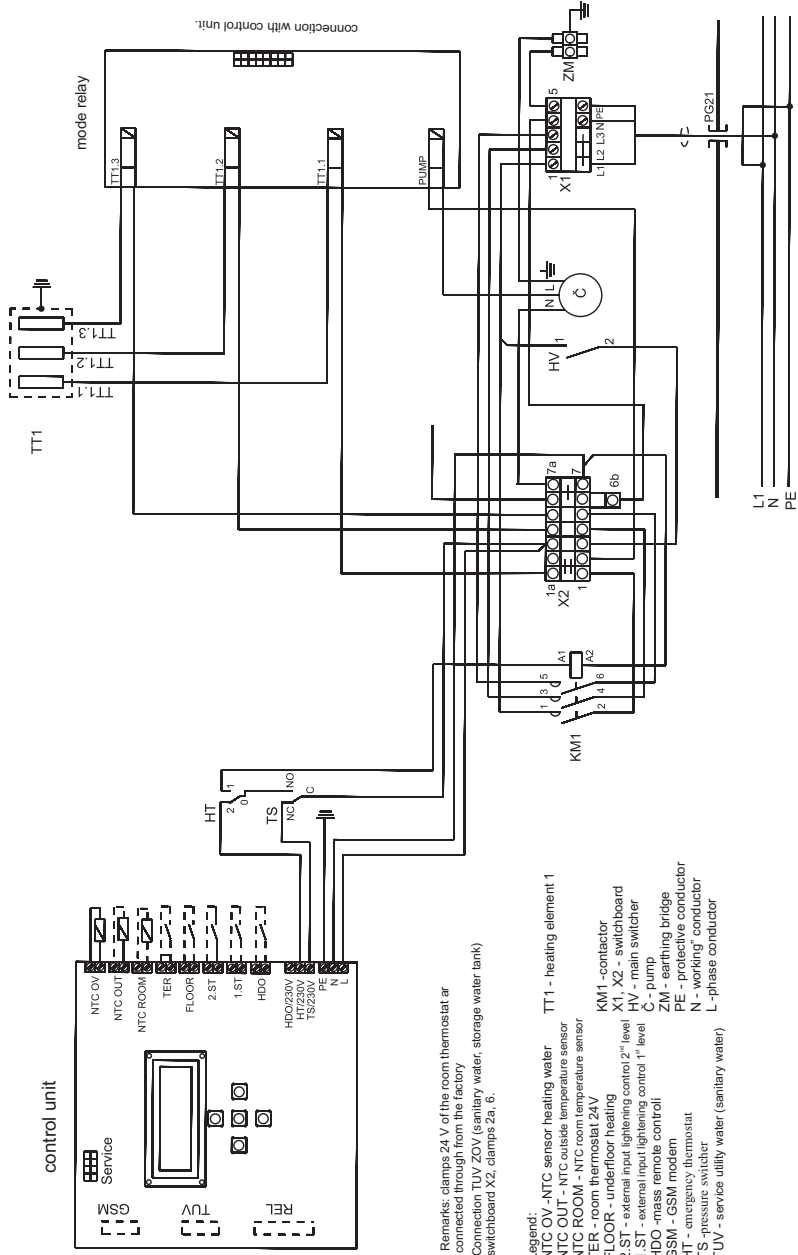

Remarks: clamps 24 V of the room thermostat are connected through from the factory
 Connection TUV ZOV (sanitary water, storage water tank)
 switchboard X2, clamps 2a, 6.

- Legend:
- NTC OV - NTC sensor heating water
 - NTC OUT - NTC outside temperature sensor
 - NTC ROOM - NTC room temperature sensor
 - TER - room thermostat 24V
 - FLOOR - underfloor heating
 - 2-ST - external input lightening control 2nd level
 - 1-ST - external input lightening control 1st level
 - HDO - mass remote control
 - GSM - GSM modem
 - HT - emergency thermostat
 - TS - pressure switcher
 - TUV - service utility water (sanitary water)
 - TT1 - heating element 1
 - X1, X2 - switchboard
 - HV - main switcher
 - C - pump
 - ZM - earthing bridge
 - PE - protective conductor
 - N - working conductor
 - L - phase conductor

Circuit diagram TUV ZOV (sanitary water, storage water tank) of the boiler EK 24K

Remarks: clamps 24 V, of the room thermostat ar connected through from the factoryConnection TUV ZOV (sanitary water, storage water tank) switchboard X2, clamps 2a, 10a.

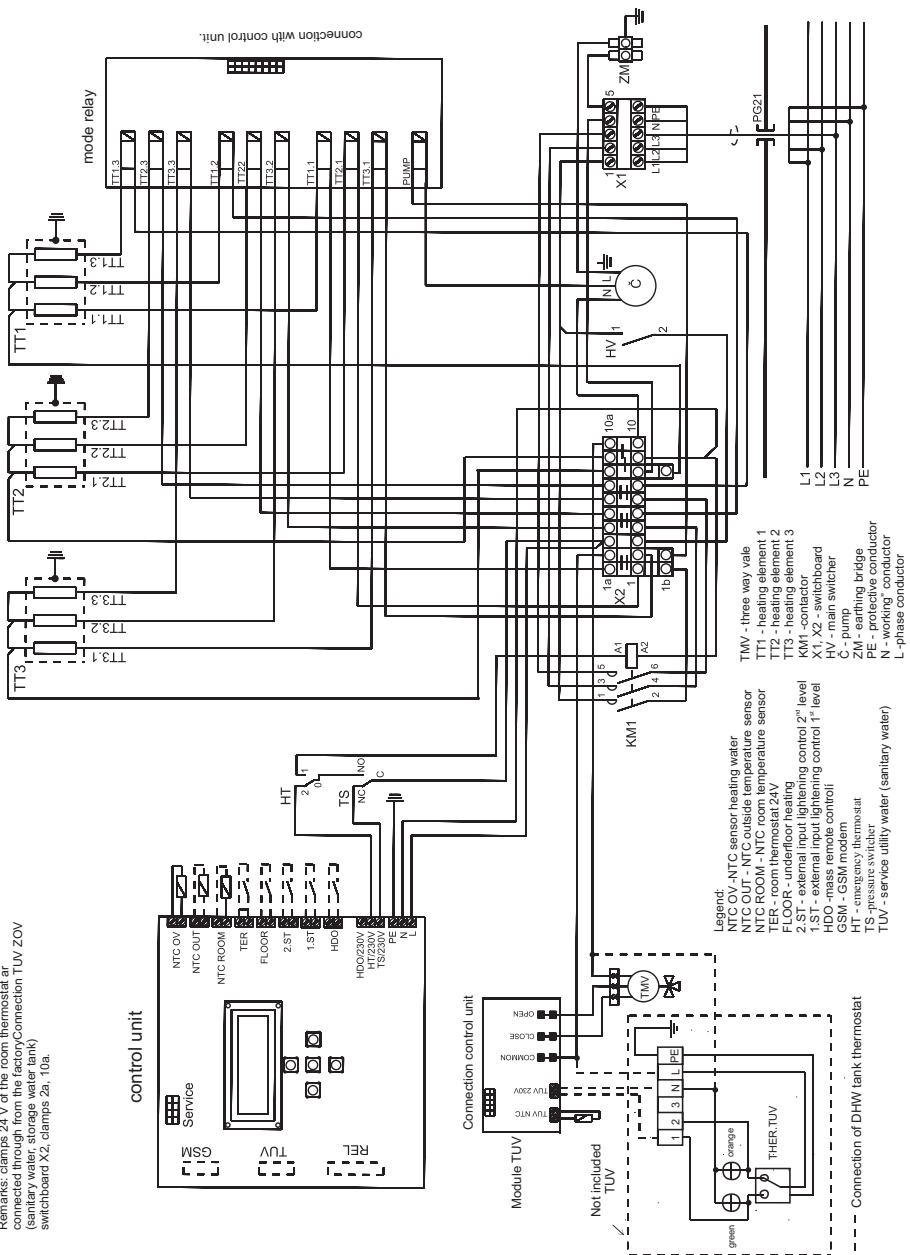

2. Maintenance

2.1 Control panel

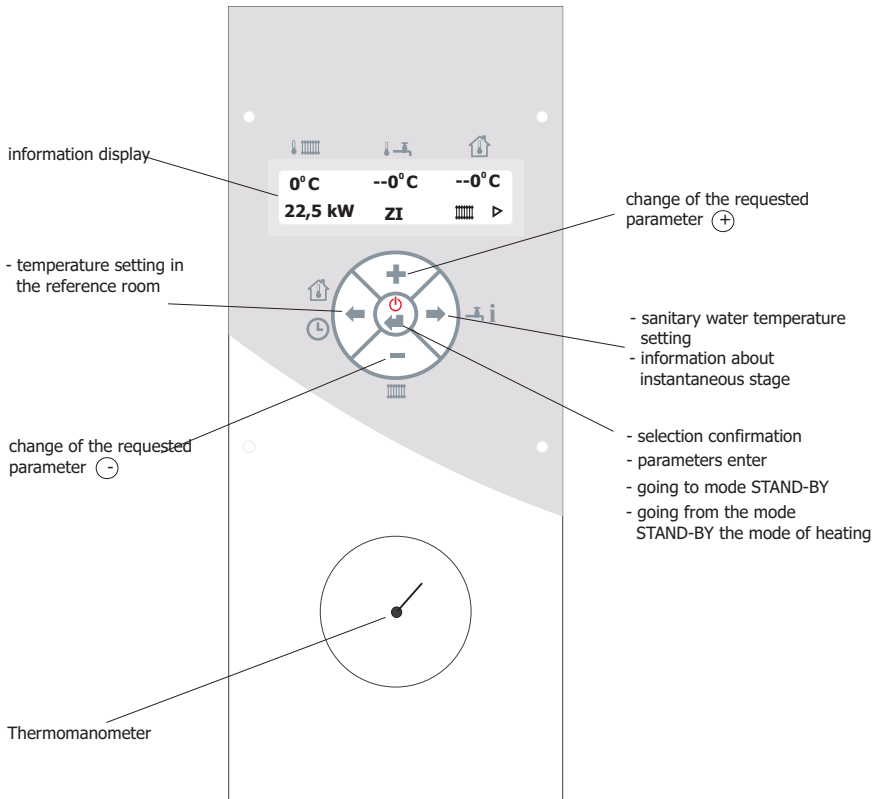

Display

- Basic information displayed

instantaneous temperature of heating water

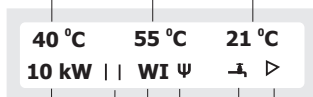

instantaneous output of the boiler in kW

instantaneous temperature of sanitary water in the storage water tank (only if the boiler has TUV (sanitary water) mode and TUV (sanitary water) sensor connected)

instantaneous temperature in referring room (in case of referring room sensor connection)

pump operation
- marking is lightning and the pump is in an operation
- marking is not lighting and the pump is switched off

signaling of instantaneous stage of the boiler
- ⚡ the boiler is in an operation of storage water tank heating (only if the boiler has TUV mode)
- 🌊 the boiler is in and operation of heating water
- S - (Soft start) SOFT START - see parameter P11

signaling of instantaneous stage of GSM (only if the boiler has GSM mode)
- Ψ - GSM in an operation
- @ - receiving/sending SMS

signaling of the instantaneous boiler mode
WI - mode "WINTER" (heating water and storage water tank heating)
SU - mode "SUMMER" (only storage water tank heating, if the boiler has TUV (sanitary water) mode connected)

HDO
- vysoký tarif
- nízký tarif

- Information display

-use for editing of instantaneous values of the electric boiler

-enter to information display is available after long (approx. 4s) pushing or 4x short pushing ➡

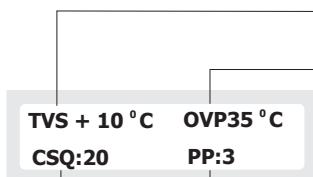

instantaneous temperature of outside sensor (only if it is connected)

requested and calculated temperature of the heating water (according to an equithermic curve)

last breakdown in the boiler memory

GSM signal intensity (1- 30) (only if GSM mode is connected)

2.2 The boiler switching ON/OFF

Use the switcher 0/1 placed on the right corner of bottom side of the boiler (see the picture 1.6 Main parts)
On the display there is displayed introductory information after boiler's switching on.

Example::

E - KOMFORT: 22,5 kW
TUV: NE VER.1.20

- electric boiler ELECTRIC EXCELLENT with output 22,5 kW
- TUV mode is not connected, SW version 1.20



**Switchboard of the boiler and inlet conductors and clamps of the contactor and inlet conductor of the switcher are under voltage!
Disconnect the boiler from the main electric inlet supply!**

2.3 Modes

Important information for setting

- during editing "help" is lighting in the low line for the value to be set
- during the first pushing of each button the editing is not active
- in delay in setting more than 10 s the editing is without the change, it means that the setting is going back to the starting position (only if the editing was not confirmed ☺)
- each value set has to be confirmed by button ☺ .
- if the value setting is not wanted or wrong (for example entering the parameters setting), wait 10 s and the boiler is automatically going back to starting basic display or it is also possible to "enter" the parameter by pushing the button ☺,☺ .
- By holding the button ☺, ☺ the setting value will automatically rolls up or down
- In case of wrong parameters setting it is possible to go back to "factory setting" according to these steps: switch off the boiler using the main switcher, push together ☺ ☺ ☺ and switch on the boiler. On the display there is "reset of factory parameters" and after OK is displayed then the parameters are according to factory setting.

Main operation modes

Operation mode "winter"

- on the display there is "WI"
- this operation mode is active always when the temperature of heating water is set (it means the operation mode "SU" is not lighting). In this operation mode the boiler is heating the system and also the storage water tank (if it is connected through)

Operation mode "summer"

- on the display there is "SU"
- this mode is possible to activated by reducing the

temperature of heating water using the button - below 25° C and confirmed this by ☺ .In this operation mode the boiler is heating only the storage water tank (3-ways valve is permanently in position in position "tank"). It is possible to go from this operation mode to operation mode "Winter" by increasing of heating water temperature using ☺ and confirm it by ☺ .

Operation mode "stand by"

- on the display there is ☺
- this operation mode is activated by long pushing (3 s) the button ☺ and deactivated by short pushing ☺ .
- Concerning this operation mode there are only active protective functions described in the chapter 1.7.4

2.3.1 Mode heating (heating water)

- on the display there is the symbol ■■■■
- this manual mode is active in operation mode "WINTER" "WI"

Without the room thermostat connected

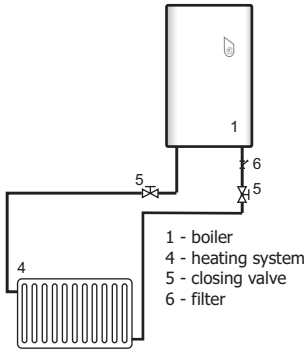

Regulation is depended on the temperature of boiler water requested by the user and hysteresis set by the parameter P20 in the scale 1 - 10 °C. (This parameter could be set only by authorized service person).

Steps for temperature setting of heating water:

Set the temperature requested by pushing , on the control panel , on the display is temperature and "OV TEPLOTA" and confirm by .After confirmation you will go back to the basic display. The boiler is now heating to the temperature requested by you. The scale of temperature setting is 25 80 °C (regarding the setting below the temperature value 25 °C the marking of operation mode "SUMMER" = "SU" is lighting, going back to heating mode is possible only by increasing the temperature of heating water by the button) .

If you don't confirm the value during editing till. 10 s, the boiler is automatically goes back to the previous setting. We recommend you to use the room thermostat for economical operation of your heating system

With the room thermostat

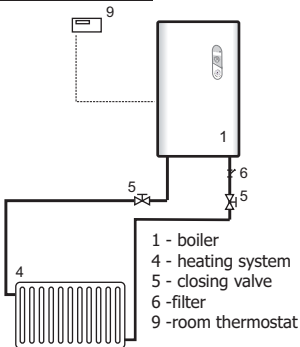

In case that the room thermostat is connected the regulation of temperature is the same as in case without the room thermostat connected till the moment when the request for heating is stopped by the room thermostat.

With the room sensor connected (on the display there is marked by the symbol .

In case that the room sensor is connected (the order number of set is 4050485) the boiler is heating according to the temperature in a reference room with hysteresis 1 °C. Actual temperature in the reference room is displayed under the symbol .The room sensor is connected on the clamps of the control unit marked NTC ROOM.

Steps for setting of temperature in a reference room

Press the button on the control panel, for setting of the temperature requested press for its increasing or for its decreasing and confirm it by . After this confirmation you will go back to main display. Temperature could be set in scale from 5 to 35 °C, if the temperature is decreased below 5°C the regulation function is switched off on the basis of reference room temperature. The boiler is controlled by the same way as in previous 2 samples without the importance of the temperature in reference room. The temperature will not be shown on the display.

Remarks: if you have reference room temperature regulation activated then this regulation is priority (and the boiler will not reply to room thermostat).

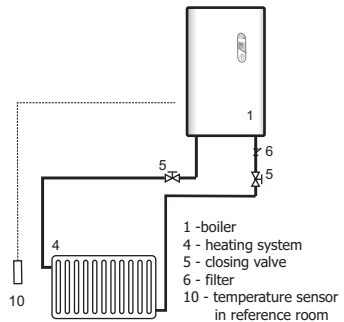

Steps for setting of temperature in a reference room with GSM modem (Only if you have GSM modem order No. 9566.2010 connected to the boiler)

The temperature in a reference room it is possible to set also like a remote control through SMS in a format example *22 (star, temperature in °C without spaces) according to the way described in a instruction manual of GSM modem.



GSM module works only in the nets with standardized GSM protocol.

With equithermic regulation

► equithermic regulation is not depended on instruction from control elements of the boiler, it is determined only for setting the temperature of heating water on the basis of outdoor temperature.

► this mode it is possible to be activated by connection of outdoor sensor (set of outside sensor order No. 4841815 of control unit "NTC OUT") and setting of equithermic curve regulation is done by the parameter P8.

Below mentioned equitermic curves are calculated for room reference temperature 20 °C.

equitermic curves of control panel

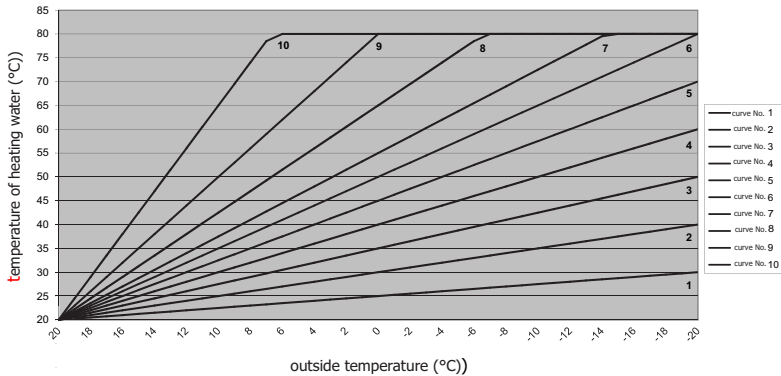

Temperature of heating water for heating will be automatically calculated on the basis of the outdoor temperature according to the curve chosen and change of starting point (parameter P9) without dependency of heating water temperature setting.

Steps for setting are described in a chapter "Setting of parameters".

Disconnecting of equitermic regulation is necessary to carry out with the parameter P8 and with decreasing of the equitermic curve number value under the value "1" till the text "NE" is displayed.

2.3.2 Mode TUV (sanitary water) is displayed →

- This mode is able to be activated after connection of TUV mode order No. 9566.2000,
- This mode is active in operation mode "summer", "winter" and is activated after request for heating into the storage water tank.,
- Temperature of water in the storage water tanks is controlled directly by connection of TUV sensor in the TUV mode or indirectly with storage thermostat which gives information to the boiler heat/don't heat through the connection of connection of contactors to the clamps on the mode TUV.

With connection of TUV sensor

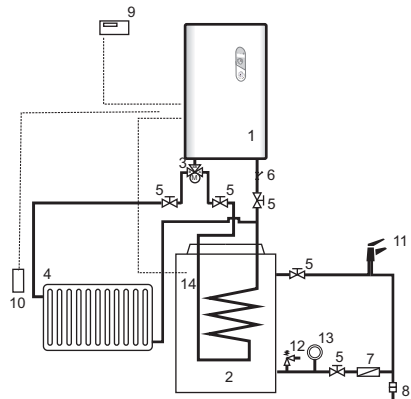

- | | |
|------------------------|--|
| 1 - boiler | 8 - treatment place for water |
| 2 - storage water tank | 9 - room thermostat |
| 3 - 3-ways valve | 10 - reference room temperature sensor |
| 4 - heating system | 11 - consumption place |
| 5 - closing valve | 12 - safety valve for TUV (sanitary water) |
| 6 - filter | 13 - expansion valve |
| 7 - back flap | 14 - sensor of storage water tank |

- ▶ the boiler will hold the temperature set in the storage water with hysteresis set by the parameter 21 in a scale 1 10 °C (Remarks this parameter is able to be set only by service authorized person).

Steps for setting of TUV (sanitary water) temperature:

Press , on the control panel and for setting of the temperature requested press for increasing and for decreasing of temperature and confirm it by . After its confirmation you go back to the main display. Temperature is able to be set in a scale 30 - 65 °C, if temperature is reduced below 30 °C then the boiler will switch off heating of TUV. On the display there is displayed "VYP" instead of temperature value. The boiler will not answer to the temperature in the storage water tank.

With connection of thermostat clamps to the storage water tank

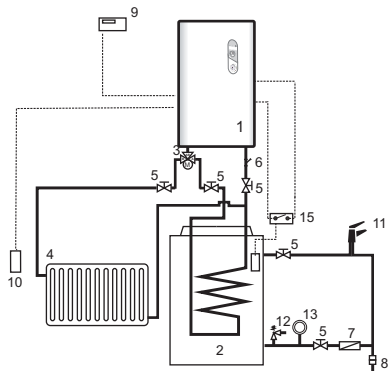

- | | |
|--------------------------|--|
| 1 - boiler | 8 - treatment of sanitary water |
| 2 - storage water tank | 9 - room thermostat |
| 3 - 3 ways motoric valve | 10 - reference room temperature sensor |
| 4 - heating system | 11 - consumption place |
| 5 - closing valve | 12 - safety valve |
| 6 - filter | 13 - expansion vessel |
| 7 - back flap | 15 - thermostat of storage water tank |

The boiler is controlled by potential-free signal ON/OFF connected to the clamps of TUV mode. In case of the request for TUV/sanitary water heating "ON" the temperature regulation is carry out for the before set temperature 80 °C. After termination of operation the boiler automatically goes back to the mode before setting. Going back to this mode is automatically, it is not possible to active it by a user.



Attention!

In the case of combination of boiler (hot water heating and floor heating) it is always necessary to intall protection against the overheating of the floor heating (f.e. mixing valve).

2.4. Setting of parameter and functions of the boiler

Parameters P20 to P28 and P33, P34 are possible to be displayed and to be set after rebuilding of service jumper on the back side of the control unit.



Change in setting of the boiler could be carried out only by authorized service person!



After cover removing there is threat of emergency of electric shock!

For your easy orientation and setting is enclosed a help table of parameters:

Parameter marking	Information/value displayed in English	Importance	Setting value	Factory setting	Autorization	Min. version of the boiler
-	HW setting	Setting of heating water temperature, going to "summer" operation mode under 30 °C (symbol of summer = tap)	30 to 80, step1	60	User	1
-	DHW setting	Setting of sanitary (domestic hot water) temperature, going to switch off mode under 30°C ("-" is lightening on the display instead of temperature value)	30 to 65, step1	50	User	2
-	Room setting	Setting of temperature requested in reference room under 9°C, termination regulation on basis of temperature in reference room ("-" is lightening on the display instead of temperature value)	5 to 35, step1	Off	User	1+A2
P1	Language	Language	CZ, EN,FR,SK,DE	EN	User	1
P2	Backlighting	Permanent backlighting of display	YES, NO	Yes	User	1
P3	Pump runout set	Pump running out	Time, temperature	Temperature	User	1
P4	Time pump runout	Time of pump running out	1 to 30, step 1 min	10	User	1
P5	Temperature pump runout	Temperature of pump running out	25 to 70, step1°C	40	User	1
P6	Floor temp. limit	Underfloor heating - temperature limitation	No, 20 to 55, step1°C	No	User	1
P7	Antifrost	Antifrost protection	YES, NO	Yes	User	1
P8	Equithermic curves	Selection of equithermic curve	No, 1 to 10, step1	No	User	1+A1
P9	Equithermic curve - start	Moving of start point of equithermic curve	20 to 30 °C, step1 °C	20	User	1+A1
P10	Tempering	Tempering - outside temperature	No, 0 to 10, step1°C	No	User	1+A1
P11	Soft start temp.	Temperature setting delay with soft start	No, 30 to 80, step1 °C	40	User	1
P12	Soft start time	Time settling delay	1 to 60, step1 min	1	User	1
-	-	-	-	-	-	-
-	-	-	-	-	-	-
-	-	-	-	-	-	-
-	-	-	-	-	-	-
-	-	-	-	-	-	-
P18	P-constant	Regulation constant P	0 to 99, step1%	50	Producer	1
P19	I-constant	Regulation constant I	0 to 99, step1%	50	Producer	1
P20	HW hysteresis	Hysteresis of heating water temperature	1 to 10, step1°C	5	Service	1
P21	DHW hysteresis	Hysteresis of TUW/sanitary water temperature	1 to 10, step1°C	5	Service	1
P22	High T - max P HW	Maximal output for heating system with HT	0 to (2,5) step(2,5)kW	0	Service	1
P23	High T - max P DHW	Maximal output for storage water tank heating with HT	0 to (2,5) step(2,5)kW	0	Service	1
P24	Low T - max P HW	Maximal output for heating system with HDO (mass remote control)	0 to (2,5) step(2,5)kW	22,5	Service	1
P25	Low T - max P DHW	Maximal output for storage water tank heating with HDO (mass remote control)	0 to (2,5) step(2,5)kW	22,5	Service	1
P26	EIC 1	External lightening of boiler input 1 - lightening of input	0 to (1,5) step(2,5)kW	0	Service	1
P27	EIC 2	External lightening of boiler input 2	0 až (1,5) kro(2,5)kW	0	Service	1
P28	Manual low T	Manual HDO (mass remote control)/switching on, after 10 min. going back NO	HDO?(mass remote control), O.K.	HDO?	Service	1
P29	PIN	PIN	Number in a format of 4 place	1234	User	3
P30	User 1	User 1	Phone number according to country	-----	User	3
P31	User 2	User 2	Phone number according to country	-----	User	3
P32	User 3	User 3	Phone number according to country	-----	User	3
P33	Errors - memory	Errors/breakdowns memory		-	Service	1
P34	Errors - memory erase	Errors/breakdowns memory deletion	O.K.	-	Service	1
P35	1 ROD POWER OUTPUT	1 heating rod power output setting	1 kW to 4 kW, step 0.1	2,5	Producer	1

max. boiler output

according to parameter P35

max. output

according to parameter P35









Version of boiler
 Version of boiler1 = basic (control unit + relays mode)
 Version of boiler2 = TUW/sanitary water = (control unit + relays mode + TUW mode)
 Version of boiler3 = GSM = (control unit + relays mode + GSM mode)
 Version of boiler4 = Full = (control unit + relays mode + TUW mode + GSM mode)



Accessories
 A1 - Outside sensor (Order No.: 4841815)
 A2 - Reference room sensor (Order No.: 4050485)
 TUW set/mode (Domestic hot water/sanitary water) - Order No.: 9566.2000
 GSM mode/set - Order No.: 9566.2010

Function and its setting



The electric boiler is equipped with several useful functions assuring its comfort and economical operation. Putting the boiler into operation it is necessary to set carefully boiler's function by setting of parameters for right function of the boiler and heating system. On the lower line of display there is "help" lighted for easy operation and setting of the parameter.

Setting of parameters

Press shortly  and now you are in the display for setting the parameters. Use  and  and list the number of parameter which you want to change. It is necessary to press  for editing of the parameter (editing is shown by \pm on the right lower corner), now you can change the value of the parameter setting by  or , or move in the parameter by  or  during setting the phone numbers or PIN code (parameters 29, 30, 31, 32).

Value set or chosen by you is necessary to confirm by  for its saving (> is blinking shortly). Now you are able to change the next parameter by pressing  or , or wait approximately 10 s and the boiler goes automatically back to the basic display.

Going back to the factory setting

In case that you set the parameter wrongly or not requested, it is possible to go back to the factory setting as follows: Switch off the boiler using the main switcher and press in one time    and switch on the boiler. On the display there is "RESET TOVARNICH PARAMETRU" lighted and after O.K., the factory parameters are in the factory setting.

Description of parameters

Heating water temperature, sanitary water temperature and temperature in a reference room were described in previous chapters.

P1- Language (CZ, EN,FR,SK,DE)

- setting of language for communication of the boiler on its display and for sending SMS about breakdowns (GSM mode)
- CZ Czech language, EN English language, FR French, SK Slovak, DE German language

P2- Possibility of permanent lighting of display (Y/N)

- Y the display is lighting permanently
- N the display is lighting only during its activation by pressing of a button, for 30 s

Remarks: if you press firstly and shortly, editing is not in a process only the display is lighting.

P3-Pump time running out (time, temperature)

Setting of time running out after termination of request for heating

- Time for time pump running out with time set by the parameter P4
- Temperature for temperature pump running out with temperature set by the parameter P5.

P4-Time pump running out (1- 30 s)

Time setting for pump running out after termination of request for heating.

Remarks: In case that the request for heating of sanitary water is terminated in winter operation mode there is activated time pump running out set previously 1 min. into heating system. In case of the summer operation mode there is time running out 1 min. into storage water tank.

P5-Temperature pump running out (25 - 70° C)

- temperature setting, if the temperature will be over the temperature set, the pump will be in a operation.

Remarks: In case that the request for heating of sanitary water is terminated in winter operation mode there is activated time pump running out set previously 1 min. into heating system. In case of the summer operation mode there is time running out 1 min. into storage water tank.

P6-Temperature limit for underfloor heating (NO, 25 - 55°)

- limitation of maximal temperature of heating water with using the boiler for underfloor heating without the priority of heating water set.

Remarks: In case of active equithermic regulation the boiler will "cut" by this temperature the equithermic curve set.



Always it is necessary to assure the protection of underfloor heating system circle against overheating using the external equipment (for example mixture valve or limit thermostat for underfloor heating, its clamps are able to be connected to the control unit on the position of emergency thermostat of underfloor heating).

Remarks: The boiler has the clamp for underfloor heating thermostat connection (on the control unit there is marking "FLOOR"). In case that temperature is higher than the temperature set by this thermostat then control unit will disconnect or output levels and stop the pump operation.

We recommend you installation of this thermostat to avoid overheating of underfloor heating system

P7-Antifrost protection (Y/N)

- This function protects the boiler against boiler icing.
 - In case that the boiler water temperature falls down below 5° C the boiler will switch on the pump operation and will heat to 15° C. After that the boiler goes back to the stage before antifrost protection starting. The pump running out is activated for 1 min. This function is active in all the modes.
- Y function is active according above mentioned steps.
- N function is not active (for example in systems there are the antifreeze liquid additives.



In case of deactivation of this function there is a threat of property damages. The boiler is not able to protect rooms there is the temperature lower than the temperature in the room there is the boiler placed (for example the boiler is placed in a cellar and the coldest room is in an attic).

P8- Equithermic regulation (NO, 1 to 10)

- this function activates the boiler regulation on the basis of dependency of heating water temperature calculated and outdoor temperature according to an equithermic curve and its movement.
- NO equithermic regulation is not active
- Number 1- 10 number selection of a optimal curve for heating system. Description of equithermic regulation see the point 2.3.1

P9- Selection of equithermic curve start-point movement (20 - 30 °C)

You set the start-point of the curve, it means that it is possible to increase the temperature till for 10 °C.

- The number 20 - 30 °C = temperature of start-point equithermic curve.

P10-Tempering function (NO, 1 to 10 °C)

- This function is the same as antifrost protection (P7) with a difference that the temperature after function activation is measured by outside sensor. If the outside temperature is lower than the temperature set then the boiler will hold the boiler water on 15 °C till the moment when the outside temperature will increase over the temperature set.
- NO this function is not active
- The number 0 - 10 °C outside temperature for activation/deactivation of tempering function

P11-Selection of soft start function (NO, 30 - 80 °C)

- This function assures stabilization of heating system in cold stage (during switching on with the main switcher) in dependency on temperature requested by the parameter 12. During activation "S" is lighting on the display.
- NO function is not active
- The number 30 - 80 °C heating water temperature which the boiler operation is hold on set by the parameter P12.

P12- Selection of lag (delay) in soft start (1 -60 min.)

- If the function of soft start is activated, it is possible to set the time for staying the boiler in the temperature set by the parameter P11. If the function is deblocked by the parameter P11 then the parameter P12 is not active.
- The value 1 to 60 = time in minutes for setting of lag (delay).

P18- Selection of regulation constant P

- selection of regulation constant has an influence for boiler water temperature regulation



This parameter could be set only by authorized service technique!

This constant could be changed only according to producer instructions!

P19- Selection of regulation constant I

- selection of regulation constant has an influence for boiler water temperature regulation



This parameter could be set only by authorized service technique!

This constant could be changed only according to producer instructions!

P20 -Selection of hysteresis of heating water temperature (1 - 10 °C)

- if you use this parameter you will be able to set temperature difference between switching on temperature of boiler water and temperature requested.
- The value = 1 to 10 °C hysteresis in °C. If you select the lower hysteresis of heating water then you increase the number of heating cycles that could cause reducing of life time of relays!



This parameter could be set only by authorized service technique!

P21- Selection of hysteresis of TUV (sanitary water), (1 - 10 °C)

- if you use this parameter you will be able to set temperature difference between switching on temperature of water in the storage water and temperature requested.
- The value = 1 to 10 °C hysteresis in °C. If you select the lower hysteresis of heating water then you increase the number of heating cycles that could cause reducing of life time of relays!



This parameter could be set only by authorized service technique!

P22- Selection of maximal output for heating of whole system with high price tariff (HT),(0- 22, 5 kW)

- Using this parameter you are able to limit output of the boiler for heating system during its operation with high price tariff (HT).
- Value 0 to 22.5 maximum power output in kW, the step according to the mounted heating rod type (see Parameter Tab., P35).



This parameter could be set only by authorized service technique!
Operation of the boiler in HT is possible only on the basis of permission of official electricity network distributor!

P23-Selection of maximal output for heating of TUV (sanitary water) with high price tariff (HT), (0 - 22,5 kW).

- Using this parameter you are able to limit output of the boiler for heating into the storage water tank TUV (sanitary water) with high price tariff (HT).
- Value 0 to 22.5 maximum power output in kW, the step according to the mounted heating rod type (see Parameter Tab., P35).



This parameter could be set only by authorized service technique!
Operation of the boiler in HT is possible only on the basis of permission of official electricity network distributor!

P24-Selection of maximal output for heating of whole system with low price tariff (NT), (0- 22, 5 kW)

- Using this parameter you are able to limit output of the boiler for heating system during its operation with low price tariff (NT) HDO (mass remote control) signal.
- Value 0 to 22.5 maximum power output in kW, the step according to the mounted heating rod type (see Parameter Tab., P35).



This parameter could be set only by authorized service technique!

P25-Selection of maximal output for heating of TUV (sanitary water) with low price tariff (NT), (0 - 22, 5 kW)

- Using this parameter you are able to limit output of the boiler for heating into the storage water tank TUV (sanitary water) with low price tariff (NT) HDO (mass remote control) signal.
- Value 0 to 22.5 maximum power output in kW, the step according to the mounted heating rod type (see Parameter Tab., P35).



This parameter could be set only by authorized service technique!

P26-Selection of lightening relay function in 1st level (0 - 12, 5 kW)

- Using this parameter you are able to set how the nominal output will be lighted in case of the signal of 1st level from the lightening relay placed in consumer board unit.

- Value 0-half the max. power output, a step by the set value of parameter P35.



This parameter could be set only by authorized service technique!

P27-Selection of lightening relay function in 2nd level (0- 12, 5 kW)

- Using this parameter you are able to set how the nominal output will be lighted in case of the signal of 2nd level from the lightening relay placed in consumer board unit.
- Value 0-half the max. power output, a step by the set value of parameter P35.



This parameter could be set only by authorized service technique!

P28- Selection of manual switching on of HDO (mass remote control) signal

- Using this parameter it is possible to simulate the HDO signal (activation of low price tariff NT). This parameter is automatically deactivated after 10 min. This parameter is only for service and after sales purposes including boiler setting.
- HDO (mass remote control) it is not active.
- O.K. HDO is activated after its confirmation for 10 min.



This parameter could be set only by authorized service technique!

P29- Selection of safety PIN code

- Using this parameter it has to be set PIN SIM card inserted in GSM mode. In case that SIM card is not by PIN protected, this number could each one.
- The value xxxx four places number.



For this possibility of remote GSM control of the boiler it is necessary to buy a GSM model!
If you insert the wrong number of PIN then you could block the SIM card!

P30-Selection of the user No. 1 responsible for remote GSM communication with the boiler

- Using this parameter it has to be inserted GSM mobile phone number of the user responsible for remote GSM communication with the boiler through SMS. The number has to be inserted in the international number format and if the number is shorter than 13 places then it is necessary to insert for free ending place "N".
- The value 0, 1, 2, ...,9, N + - marking of phone number



**For this possibility of remote GSM control of the boiler it is necessary to buy a GSM model!
GSM module works only in the nets with standartized GSM protocol.**

P31-Selection of the user No. 2 responsible for remote GSM communication with the boiler

- Using this parameter it has to be inserted GSM mobile phone number of the user responsible for remote GSM communication with the boiler through SMS. The number has to be inserted in the international number format and if the number is shorter than 13 places then it is necessary to insert for free ending place "N".
- The value 0, 1, 2, ..., 9, N + - marking of phone number



**For this possibility of remote GSM control of the boiler it is necessary to buy a GSM model!
GSM module works only in the nets with standartized GSM protocol.**

P32 -Selection of the user No. 3 responsible for remote GSM communication with the boiler

- Using this parameter it has to be inserted GSM mobile phone number of the user responsible for remote GSM communication with the boiler through SMS. The number has to be inserted in the international number format and if the number is shorter than 13 places then it is necessary to insert for free ending place "N".
- The value 0, 1, 2, ..., 9, N + - marking of phone number.



**For this possibility of remote GSM control of the boiler it is necessary to buy a GSM model!
GSM module works only in the nets with standartized GSM protocol.**

P33 - Selection of breakdowns archive view

- Using this parameter you are able to display 4 breakdowns history with its description and frequency. Last breakdown it is possible to display on the information display (see description information display).



This parameter could be set only by authorized service technique!

P34- Selection of breakdowns clearing

- Using this parameter you are able to delete the history of breakdowns.



This parameter could be set only by authorized service technique!

P35 - Heating rod power output selection

- A heating rod power output can be selected by selecting this parameter the actual power output will be shown on the display on the basis of this value.



Only the manufacturer is authorized to set this parameter!

2.5. Errors/breakdowns

Table of errors/breakdowns displayed

Critical defect	Importance	Reset	Possible cause	Elimination	Archive of breakdowns symbol
1	Invalid sensor of heating water (shunt fault).	Automatic	Invalid sensor or cable fault.	Call service	Err3
2	Invalid sensor of TUV temperature (shunt fault)	Automatic	Invalid sensor or cable fault.	Call service	Err3
3	Invalid sensor of temperature in the reference room (shunt fault)	Automatic	Invalid sensor or cable fault.	Call service	Err3
4	Loose of pressure in the heating system	Manual reset of the boiler	Water underpressure of heating system = under 0,4 bar.	Control tightness of heating system, fill the water and reset the boiler.	Err1
5	Boiler overheating	Manual reset of the emergency thermostat	The temperature in the boiler is higher than emergency one - for example the pump breakdown, breakdown of heating element, aeration...	Call service	Err2
6	Electronics breakdown	Automatic	Wrong connection of relay mode or TUV mode or invalid control unit.	Call service	Err4
7	Floor overheating	Automatic	Temperature of heating water set by limitation thermostat of underfloorheating is higher.	Call service	Err2
8	Breakdown in inlet supply (overvoltage in the network)	Automatic	Overvoltage on the inlet clamps of the control unit.	Call service	Err4
99	More than 1 breakdown in one time.	-	More than 1 breakdown in one time, failures are displayed in turns.	Call service	-

Others errors/breakdowns non displayed

Breakdown	Possible cause	Elimination
The text „Rele Modul Error“ is displayed after the boiler start.	Wrongly connected relay modul, defective relay modul, defective control system	Restart the boiler, in case that the breakdown has not been eliminated, call service.
Boiler display is not lightening	Mistake in inlet supply of the boiler, network under-voltage, invalid control unit or software is missed.	Restart the boiler, in case that the breakdown has not been eliminated, call service.
Temperature displayed is not in accordance with real temperature value	Sensor is disconnected or invalid or broken.	Call service.
It is not possible to connect GSM modem	The net falls short of GSM protocol, wrong PIN, defective GSM modul	Control the PIN code edited by the parameter P29.
It is not possible to control the boiler by GSM SMS instruction	Wrong format of user phone number.	Control the format of phone number edited by the parameter P30, P31, P32.
	Wrong format of SMS` s instruction.	Control the format SMS according to the description in the chapter "Installing" including interspaces.
	Wrong receiver` s data (SIM card in the boiler).	Control if the phone number of SIM card of the boiler is correct written.
	SIM card has not a free memory capacity for receiving of SMS.	Delete all SMS from the SIM card of the boiler.
	SIM card is blocked by the GSM operator.	Call your GSM operator SIM card of the boiler.



In case that the boiler has an error/breakdown and it is necessary to call service, don't try to remove the breakdown by yourself. There is a dangerous of a threat of electric shock!

3. Installation

3.1. Norms and regulations

For safety operation, projection, mounting, operation and service of boiler is valid below mentioned norms and regulations:

- ČSN 06 0310:2006 Heating systems in buildings projection and mounting.
- ČSN 06 0830:2006 Heating systems in buildings safety and protection equipment.
- ČSN 06 1008:1998 Fire safety of heating appliances.
- ČSN 07 0240:1993 Water and low pressure steam boilers basic rules.
- ČSN 07 7401:1992 Water and steam for heating energetic equipments.
- ČSN 33 1310:1990 Electrotechnical rules. Safety rules for electric equipments used by person without electric qualification.
- ČSN 33 2000 - ...Electrotechnical rules.
- ČSN 33 2130:1985 Electrotechnical rules. Inside electrical distribution system.
- ČSN 33 2180:1980 Electrotechnical rules, connection of electric appliances.
- ČSN EN 50110-1:2005 Service and work with electrical appliances.
- ČSN EN 55014:2001 Electromagnetic compatibility requirements for home appliances, electric tools and similar appliances.
- ČSN EN 60355-1+A55:1997 Safety of home electric appliances and for similar purposes.
- ČSN EN 61000 - ...Electromagnetic compatibility (EMC)
- Law No. 22/1997 Technical requirements for products.
- Government direction No. 178/1997 defined technical requirements for construction products + enclosure No. 1 basic requirements.
- Notice No. 48/1982 basic requirements to assure labour protection and safety of technical equipments.

3.2 Placement of the boiler in the room

Room where the boiler will be placed and mounted on the

wall has to be in accordance with normal environment AA5/AB5 according to ČSN 33 2000 3.

It is not allowed for boilers to be installed in bathrooms, wash rooms, shower rooms in place 0, 1, 2, 3 according to the rule ČSN 33 20007701.

Concerning fire protection and safety the rule ČSN 06 1008 is valid and there is stated minimal distance from flammable objects.

We recommend enlarging these distances to have minimal space easier service and manipulation:

- 500 mm from the front side
- 600 mm from the top
- 200 mm from the side

3.3. Mounting of the boiler on the wall

Mounting is carried out by 2 screws or hooks which the boiler is hanged on through 2 inlets with spacing of holes 280 mm on the frame of the boiler.

3.4. Electroinstallation

3.4.1 Boiler connection to electric supply net

For boiler connection to electric supply net it is necessary for user to have a license from the local energetic distribution organization. Boiler input is not allowed to be bigger than the input stated in the license.

Before mounting of the boiler it is necessary to be installed supply electric cable with main switcher and with over current circuit breaker including starting inspection revise and to have confirmed application for electric power take-off.

Electric boilers ELECTRIC EXCELLENT are ranged in appliances continuously connected to electric circuit of network voltage. In the fix supply cable of the boiler there has to be in-built main switcher with distances of all disconnected cables min. 3 mm. The boiler is connected by corresponding cables to switch board X1 according to the diagram 1.7. Inlet of cables through the cover of boiler is carried out with bushings. The bushing PG21 is for main supply inlet of the boiler.

Recommended size of circuit breaker and diameters of conductors:

Type of boiler	ELECTRIC EXCELLENT 8			ELECTRIC EXCELLENT 15			ELECTRIC EXCELLENT 24		
	Size of circuit	Cu full conductor	Cu – wire	Size of circuit	Cu full conductor	Cu – wire	Size of circuit	Cu full conductor	Cu – wire
1x230V+N+PE	1x40A	1x6	1x10	Unavailable			Unavailable		
3x230/400V+N+PE	3x16A	3x2,5	3x4	3x25A	3x4	3x6	3x40A	3x6	3x10

Maximal diameter for switch board X1 EK is 10 mm².

Other bushings PG9, PG7 are for other signals of the room thermostat and the 3-ways valve.

3.4.2 Installation of the room thermostat

- ▶ Connection of the room thermostat is necessary to do with twin core cable with recommended diameter min. Cu 0,5 mm² and length to 25 m.
- ▶ The cable for the room thermostat is not allowed to be placed in the same way with supply cord or another electric or industrial installation. Minimal separation is 10 cm.
- ▶ The switch board for the room thermostat connection (24V) is placed in the right part of the control unit from the front face, the clamp with marking TER, the room thermostat has clamps with bridge from the factory setting.

3.4.3 Installation of mode TUV (heating of sanitary water) and the storage water tank

- ▶ If you want to heat TUV (heating of sanitary water), it is necessary to connect through the electric boiler with TUV connection set and extend the control unit with TUV mode.
- ▶ The complete set consists of:
 - ▶ mode TUV
 - ▶ sensor TUV
 - ▶ 3-ways valve
 - ▶ connection cable of TUV mode to the control unit
 - ▶ connections parts and materials
 - ▶ instruction manual

Connection of TUV mode is carried on with the flat conductor to the connector on the left side of the control unit (marked TUV). It is necessary to connect a phase 230 V to switchboard X2 according to the circuit diagram with the conductor enclosed.

Connection of phase conductors of 3-ways valve is carried on to the switchboard on the TUV mode. Connection of "working zero" is carried on to the switchboard X2, the sensor of TUV temperature is connected to the switchboard on the TUV mode.

More detailed description is enclosed in the TUV connection set (package).



TUV mode connection through is able to carry on only responsible service person.

3.4.4 Installation of GSM mode control

- ▶ If you want to use the GSM control of the electric boiler then it is necessary to extend the control unit with GSM mode.

The GSM mode consists of:

- ▶ GSM modem (with basic type of aerial)
- ▶ flat conductor for connection through
- ▶ connections parts and materials
- ▶ instruction manual

GSM modem connection is carried on with the flat conductor to the switchboard GSM on the left part of the control unit. The flat conductor has to be pulled through the inlet of upper cover of the boiler. GSM modem is

necessary to screw or to fix another way to the cover of the boiler to avoid its dismantling. For GSM modem mounting use inlets on the upper cover of the boiler. If you have a not strong GSM signal from network then it is possible to buy additional external aerial determined for GSM modem SIEMENS.

Aerial parameters:

Frequency scale: 900/1800 MHz (Dual-band)

Impedance: 50 Ohm

Connector: SMA (male)

More detailed description is enclosed in the TUV connection set (package).

3.5 Heating system

The pipe system of heating system has to be made to avoid forming of air bubbles and to make easy the process of deaeration. Deaeration valves have to be placed on each highest heating system place and on all radiators. We recommend making the heating pipe from copper. Plastic pipes have to fulfill requests of heating resistance and have guaranteed heat resistance have not to loose parts in the heating water to avoid paralysation of regulation and safety function components, including the pump.

The boiler has to be installed in opened or closed heating system according to the normative conditions (overpressure of heating system, maximal volume of heating system).

The boiler could be used for underfloor heating, minimal temperature of heating water is 30°C. The boiler has not equipped by the sensor of maximal temperature of heating water for underfloor heating,, it has to be carried on by external thermostat connected by its clamps to the electric boiler.

Using of defrost mixture

We don't recommend to use defrost mixtures due to their characteristics, some of them are not convenient for the boiler operation, concretely reducing of heat transmission, big volume elasticity, ageing, breakdowns of rubber parts. It is necessary to think about to use them inevitable. Regarding inevitable situation it is allowed to use the defrost mixture Alicol Termo according to experience of the producer that the boiler operation is not reducing.

If you are not able to use this defrost mixture and you will protect your heating system with another defrost mixture then guarantee claim will not be accepted

3.6 Expansion vessel

The expansion vessel has these parameters:

Total volume 8 dm³

Overpressure of nitrogen filling 1,2 bar

Size 8 l

The expansion vessel eliminates warm elasticity of heating medium (water) in the heating system therefore it is necessary to have its sufficient volume. The size of expansion vessel is projected by a responsible person technician of heating system project. Below mentioned is a graph for your basic orientation knowledge of dependency.

Graph Dependency of expansion vessel volume on volume of heating system for thermal drop 80/60 °C.

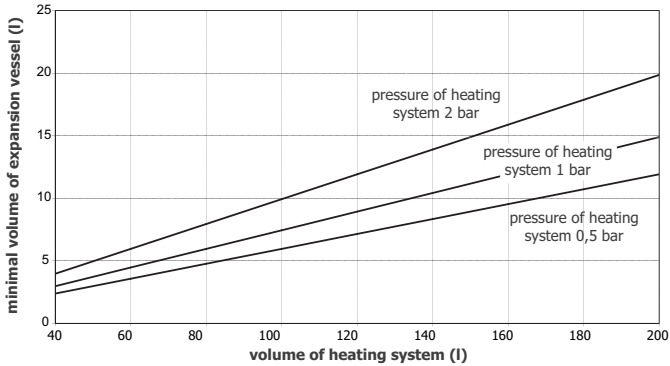

The graph is determined for thermal drop 80/60 °C and there are 3 curves with pressures of system in cold stage 0,5 and 1 and 2 bars.

In case that minimal volume requested of the expansion vessel is bigger than 8l, it is necessary to connect an additional expansion vessel into the heating system to have volume of vessels counted bigger than minimal (according to the graph). In both expansion vessels there are necessary to have a same pressure of nitrogen filling. Curves are valid for using of safety valve set on 3 bars.

Filling overpressure of expansion vessel

For right function of expansion vessel it is necessary to keep the overpressure of nitrogen filling, which is stated for 1,2 x of the heating system overpressure in cold stage.
 $P_{ex} = 1,2 \times P_{ov}$

Notice: gas filling adjustment of expansion vessel has to be provided only by responsible service person to do it.

- Obligation for user is to assure the operation revision/control 1time per year and the pressure control of the built-in expansion vessel maximally 1 time per 9 years, it means also of an additional expansion vessel if it is mounted to the heating system, only by responsible service person to do it.

Minimal overpressure of heating water

Value of minimal overpressure is stated in the table 1.5. Minimal overpressure requested has to be signed on the thermomanometer by a responsible service person who is

Pump with internal control

putting the boiler into operation. It is not allowed to drop the pressure of heating water below the margined signed on the thermomanometer. For right boiler and heating system operation is necessary to control the overpressure value sometimes and in case that the value is on requested value to fill the system on the overpressure value requested.

Filling overpressure of heating water

It is necessary to observe it in the case of the first filling or also in the case of additional filling of minimal overpressure of heating water. The filling overpressure is about 0,20 bar higher than minimal overpressure requested from reason that the temperature of heating water during filling and additional filling has to be to 20° C (water is dilatable partially by this temperature).

3.7 Marking of working scale

On the pressure meter placed under the boiler there is necessary to mark working scale that the pointer of pressure meter is moving in. Maximal pressure is marked by responsible person put the boiler into operation by pressure meter marking.

Maximal margin = maximal overpressure of heating water in time of reaching of maximal temperature of heating water.

3.8 Circle pump

The boiler is equipped with powerful circulation pump which modulate of RPM to reduce the consumption of electricity.

The pump operation is controlled by the control unit

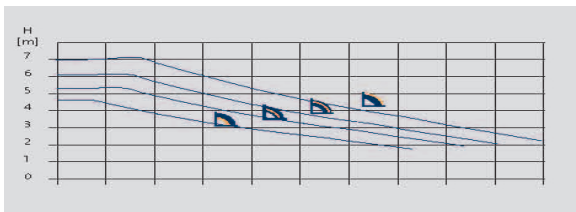

dependent on the demand of regulation and the safety traffic and heat system.

- The pump has antiblocking function. More detailed information are stated in the chapter No. 1.7.4 "Protection function of the boiler".
- Time running out of the pump make possible to take away heat accumulated in the boiler body in time of switching off the boiler. The effect is decreasing of losses, removing of temperature tops, reducing of stone and elongation of boiler life time.
- Time running out of the pump is preset from the production facility according to the point 2.4.
- The pump is protected against blocking in operation mode Stand-by. (see the chapter Protection functions). If the boiler is for longer time out of its operation switched off, we recommend, we recommend you to switch on the boiler sometimes, minimally 1x per month (see the chapter protection of function).

Electric data of the pump

	I 1/1(A)	P1(W)	Mpa
Min	0,05	4	
Max	0,52	52	0.3

P1 - pump input
I - electric current

4. Termination of operation

- Concerning termination of boiler operation carry out it by switching off the switcher in the lower part of the boiler, by switching off the main switcher on the electric supply feeding.
- Service repairs see below mentioned instructions:



Disconnect boiler from electric supply feeding by main switcher and contact your service man!

Breakdowns of the boiler have to be repair only by professional person!



**Attention!
There is threat of casualty by electric current!**

5. Maintenance

Regular maintenance helps you to eliminate possible defects. We recommend you to carry out complete maintenance 1 time per year before starting heating system. It is not allowed the taking off the cover. The user

is able to clean surface of the cover with detergents and control operation modes or fill heating water to the system checked by water pressure dawn according to the value on the thermomanometer.

The service man during the regular control and maintenance carry out tightening of all electric connection, control tightness of all connection and control quantity of water in the heating system, clean the water filter, pump, control 3-ways valve control and switching relay including starting function of the boiler. Well, also the control of all safety and switching elements will be carry out by heating operation and right function of heating elements.

6. Full delivery

The electric boiler is delivered assembled

Full delivery of electric boiler consists of:

- electric boiler assembled,
- instruction manual,
- guarantee card,
- bushing,
- deaerate valve,
- bonding of switch board to electric supply connection 1 x 230 V.

Accessories whose are not part of the full delivery:

- conductors for supply connection of boiler and three ways valve (in case that you have installed the storage water tank) and for connection of the room thermostat
- fixing set.
- Module TUV.
- Module GSM.

7. Transport and warehousing

- The boiler is protected by its packaging during warehousing and transport. It is necessary to eliminate effects of magnetic and other influences on the packaging.
- It is necessary to eliminate concussions and to avoid slighting out the boiler from the packaging.
- Manipulate with the boiler and put it into position according instruction marked on the packaging.
- Regarding warehousing is necessary to assure standard warehousing conditions (no aggressive environment without dust, temperature from 5° C to 50° C, humidity to 75 %, no expose to biological influences, shocks and vibration).

8. Claims

If you have functional and face defects on your boiler, please do not repair it by yourselves.

- Please apply your claim by the company which put your boiler into operation or by guarantee repair companies stated in the list of guarantee place.

Apply condition stated in the guarantee list.

Your claim is not valid without fulfilled guarantee list.

9. Way of liquidation

Solid waste recycling

- mold board
- PE bags, polystyrene, binding tapes
- Boiler 's recycling after its lifetime according to national normative waste recycling.

10. Enclosures

10.1 Installation of the room thermostat, see picture

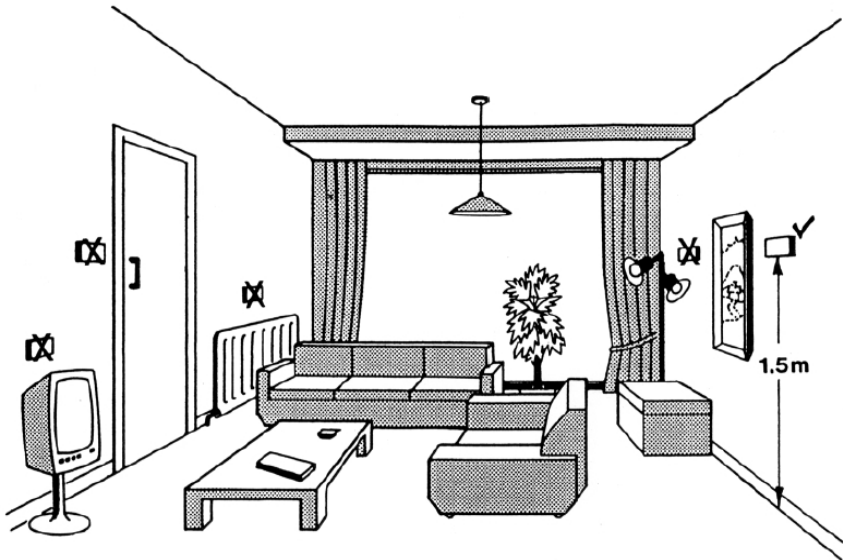

10.2. Control unit and TUV (sanitary water) mode diagram

a) control unit

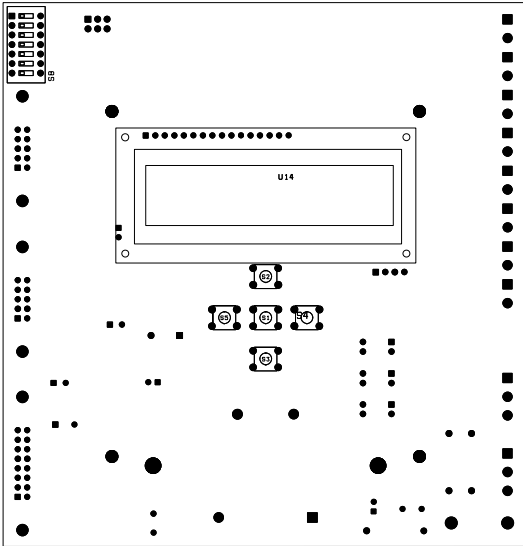

b) relays mode

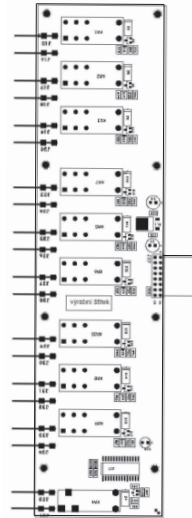

c) TUV (sanitary water) mode

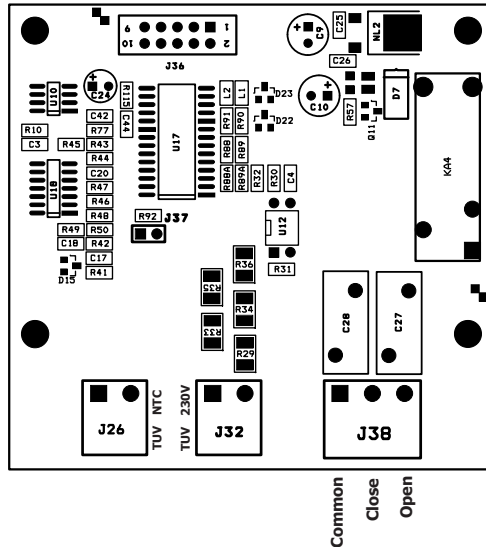



ATTACK, s.r.o. • Dielenská Kružná 5020, 038 61 Vrútky • Slovakia
Tel: +421 43 4003 101 • Fax: +421 43 3241 129 • E-mail: kotle@attack.sk
Export – tel: +421 43 4003 115 • Fax: +421 43 3241 129 • E-mail: export@attack.sk



ATTACK, s.r.o. producer reserves the right to change technical parameters and dimensions of boilers without previous warning.